



HS DOOR  BC CANADA

YOUR EXPERT FIRE RATED DOOR SUPPLIER
QUALITY & EFFICIENT DOOR MODIFICATION
SERVICE

#102 1750 Coast Meridian Road,
Port Coquitlam, British Columbia V3C6R8
Tel: 604-474-0369 Fax: 604-474-0368
<http://www.hsdoor.ca> info@hsdoor.ca



HS Door Flush Steel Commercial Door

16GA(1.5mm GA(1.1mm GA(0.9mm
A40 Galvanized Or Cold-rolled Steel Skins
Construction is 1-3/4'' (45mm) Thick kness

Hinge, closer, lock and strike plate reinforcements
shall be provided.

Hinge reinforcement: 10GA(3.5mm)

Closer reinforcement: 12GA(2.5mm)

Lock reinforcement GA(1.5mm)

Strike plate reinforcement: 16GA(1.5mm)

The top, bottom and side closures are fabricated
from 16GA(1.5mm) thick channel shaped steel sections
welded to the front and back door skins

Flush top channel GA(1.5mm)

Laser welded side seamed edge

Widths up to and including 4' 0"

Heights up to and including 8' 0"

Available with polystyrene core

DOOR

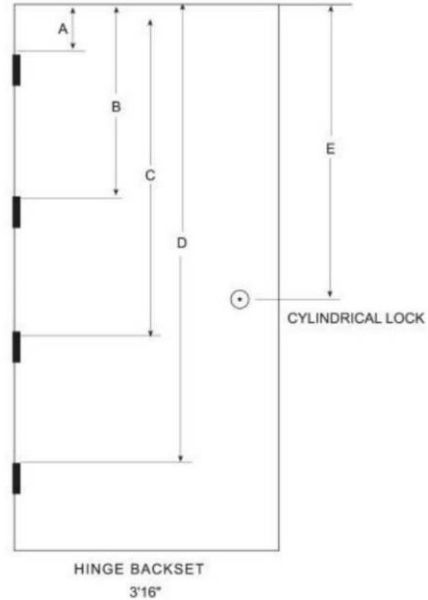

Door other locations are available, we make to request.

| Size | A | B | C | D | E |
|------|--------|----------|---------|---|----------|
| 6'8" | 7-3/8" | 37-5/16" | 67-1/4" | | 39-9/16" |
| 7'0" | 7-3/8" | 39-5/16" | 71-1/4" | | 43-9/16" |

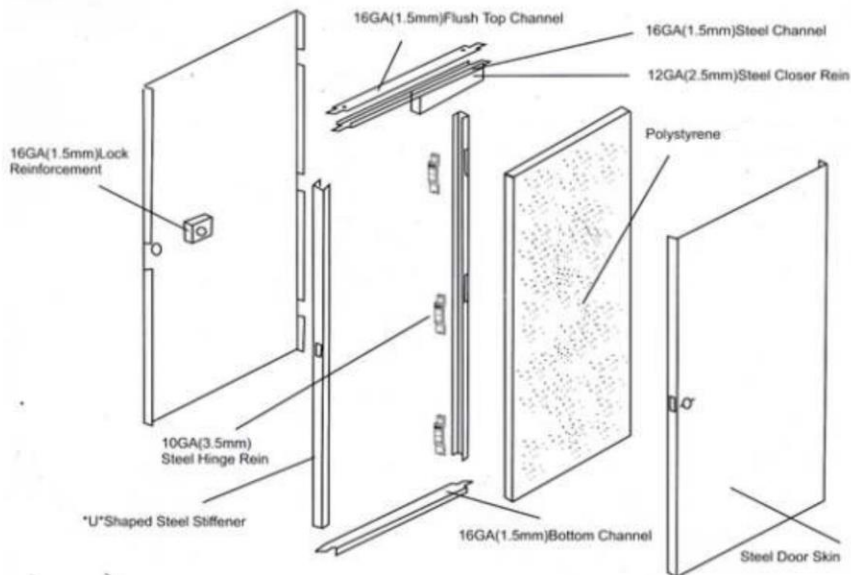

HS Door Steel Frame



Other locations are available. We make to request.

| Size | A | B | C | D | E |
|------|--------|-----------|----------|-----------|-----------|
| 6'8" | 7-1/2" | 37-7/16" | 67-3/8" | | 39-11/16" |
| 7'0" | 7-1/2" | 39-7/16" | 71-3/8" | | 43-11/16" |
| 8'0" | 7-1/2" | 32-51/64" | 58-3/32" | 83-25/64" | 55-11/16" |

Masonry double rabbet

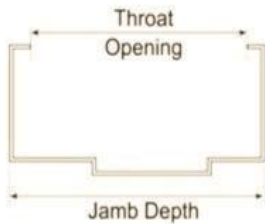

Drywall double rabbet

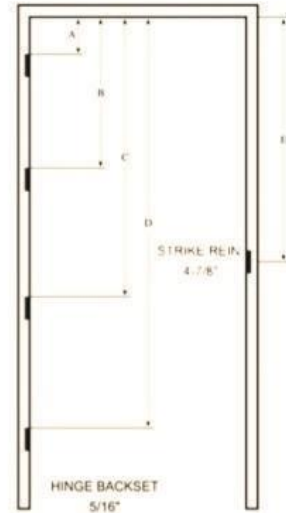
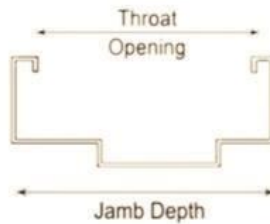

Detailed Specification

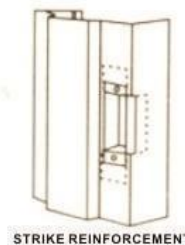
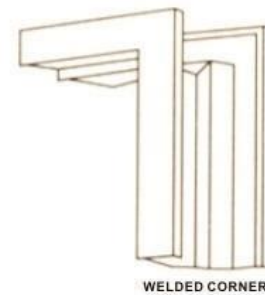
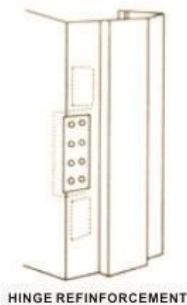
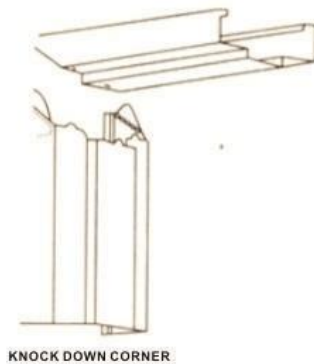

HS DOOR



BC CANADA

Workshop for door modification

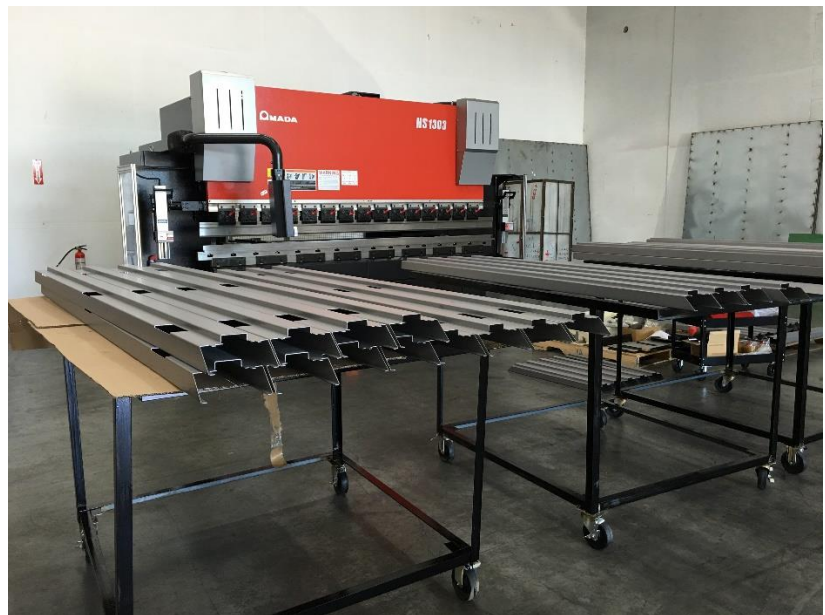

9000 ft. workshop & warehouse

Tel: 604-474-0369 Fax: 604-474-0368

<http://www.hsdoor.ca> info@hsdoor.ca



We are pleased to introduce our door modification service in British Columbia, Canada

HS Door has worked hard to develop an efficient and modern fire/entry door manufacturing facility. Using state-of-the-art technology and the latest computer-aided design techniques, we can ensure that all of our products are produced to the high industrial standards. Quality assurance is the vein that runs through all of our processes, pushing us to deliver a product that is unrivaled in both quality and affordability.

Quality & efficient door modification

We provide a door modification service that utilizes the facilities and skills of our staff. Our ongoing goals are to consistently improve our production efficiency and pass savings on to our customers. What's more, all of our products and services are fully warranted against the unlikely event of defect or breakdown.

Phone: (604)474-0369 Email: info@hsdoor.ca